

RIGOL

用户手册

RP1002C 电流探头

2014 年 02 月

RIGOL Technologies, Inc

保证和声明

版权

© 2012 北京普源精电科技有限公司版权所有。

商标信息

RIGOL 是北京普源精电科技有限公司的注册商标。

文档编号

UGE17003-1110

声明

- 本公司产品受已获准及尚在审批的中华人民共和国专利的保护。
- 本公司保留改变规格及价格的权利。
- 本手册提供的信息取代以往出版的所有资料。
- 对于本手册可能包含的错误，或因手册所提供的信息及演绎的功能，以及因使用本手册而导致的任何偶然或继发的损失，**RIGOL** 概不负责。
- 未经 **RIGOL** 事先书面许可不得影印复制或改编本手册的任何部分。

产品认证

RIGOL 认证本产品符合中国国家产品标准和行业产品标准及 ISO9001:2008 标准和 ISO14001:2004 标准，并进一步认证本产品符合其它国际标准组织成员的相关标准。

联系我们

如您在使用此产品或本手册的过程中有任何问题或需求，可与 **RIGOL** 联系：

电子邮箱：service@rigol.com

网址：www.rigol.com

一般安全概要

了解下列安全性预防措施，以避免受伤，并防止损坏本产品或与本产品连接的任何产品。为避免可能的危险，请务必按照规定使用本产品。

将产品接地。

本产品通过电源电缆的保护接地线接地。为避免电击，在连接本产品的任何输入或输出端子之前，请确保本产品电源电缆的接地端子与保护接地端可靠连接。

查看所有终端额定值。

为避免起火和过大电流的冲击，请查看产品上所有的额定值和标记说明，请在连接产品前查阅产品手册以了解额定值的详细信息。

正确更换电池。

确保没有过电压（如由雷电造成的电压）到达该产品。否则操作人员可能有遭受电击的危险。

请勿开盖操作。

请勿在仪器机箱打开时运行本产品。

避免电路外露。

电源接通后，请勿接触外露的接头和元件。

怀疑产品出故障时，请勿进行操作。

如果您怀疑本产品出现故障，请联络**RIGOL**授权的维修人员进行检测。任何维护、调整或零件更换必须由**RIGOL**授权的维修人员执行。

保持适当的通风。

通风不良会引起仪器温度升高，进而引起仪器损坏。使用时应保持良好的通风，定期检查通风口和风扇。

请勿在潮湿环境下操作。

为避免仪器内部电路短路或发生电击的危险，请勿在潮湿环境下操作仪器。

请勿在易燃易爆的环境下操作。

为避免仪器损坏或人身伤害，请勿在易燃易爆的环境下操作仪器。

请保持产品表面的清洁和干燥。

为避免灰尘或空气中的水分影响仪器性能，请保持产品表面的清洁和干燥。

防静电保护。

静电会造成仪器损坏，应尽可能在防静电区进行测试。在连接电缆到仪器前，应将其内外导体短暂接地以释放静电。

安全术语和符号

本手册中的术语。以下术语可能出现在本手册中：



警告

警告性声明指出可能会危害操作人员生命安全的条件和行为。



注意

注意性声明指出可能导致本产品损坏或数据丢失的条件和行为。

产品上的术语。以下术语可能出现在产品上：

- 危险** 表示您如果进行此操作可能会立即对您造成危害。
- 警告** 表示您如果进行此操作可能会对您造成潜在的危害。
- 注意** 表示您如果进行此操作可能会对本产品或连接到本产品的其他设备造成损坏。

产品上的符号。以下符号可能出现在产品上：



双层绝缘符号



安全警告



保护性接地端



壳体接地端



测量接地端

目录





保证和声明	I
一般安全概要	II
安全术语和符号	IV
RP1002C 电流探头简介	1
基本操作	1
电流探头与示波器的连接	1
电流探头与数字万用表的连接	3
保养	4
电池	4
安装电池	4
AC 电源适配器	5
清洁	5
装运准备	5
规格	6
电气特性	6
电压及电流额定值	7
物理特性	7
环境特性	7
认证与符合条件	8
附件	9
附录	10
附录一 1A 峰值时典型增益频率关系曲线图	10
附录二 最高电流与频率之间的关系曲线图	10
附录三 在 50mV/A 范围时典型的 DC 线性度曲线图	11
附录四 在 1A 峰值时相位与频率之间的关系曲线图（典型）	11

RP1002C 电流探头简介

RP1002C 电流探头可与通用示波器配合使用测量 AC 和 DC 电流，其显示峰值可达到 100A（70A RMS）。RP1002C 也可以将 BNC 转双香蕉插头转接器与万用表连接测量 AC 和 DC 电流。

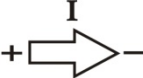
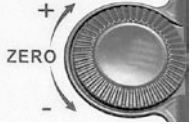

图 1 RP1002C 电流探头

控制及指示	描述
	<p>电流流动记号：箭头表示正电流流动方向。</p>
	<p>零位调整旋钮：连接电源后，将电流探头的位置固定，旋转该旋钮可调整电流探头输出的直流偏移，抵消残留电荷带来的影响。当您的仪器可以自动隔离直流分量时，测量 AC 数值时不需要做零位调整。</p>
	<p>档位开关：滑动开关可以选择 OFF、50mV/A 和 500mV/A。选择 50mV/A 和 500mV/A 任一档位时将启动电流探头，此时，电池指示灯 ON 将点亮为绿色。</p>
	<p>电源指示灯：启动电流探头时，电源指示灯将点亮为绿色，有关电池的详细说明，请参考安装电池一节介绍。</p>
	<p>过载指示灯：如果测试的数值超出选择档位的最大量程时，过载指示灯将点亮为红色并连续闪烁以警示。</p>

基本操作

使用电流探头前必须安装电池或使用本产品指定的 AC 电源适配器，有关安装电池的具体操作，请参考**安装电池**一节介绍。



注意

不可将电流探头连接至高于 600VAC 的电路上，否则将造成人身伤亡或损坏探头。



注意

连接到测试电路前，需要将 RP1002C 电流探头输出端连接到仪器上。

电流探头与示波器的连接

- 1 将示波器的耦合方式设置为直流，通过双端 BNC 同轴线缆将 RP1002C 电流探头的 BNC 接口与示波器的输入端相连。
- 2 将档位开关滑动至 50mV/A 或 500mV/A，启动 RP1002C 电流探头，此时，电池指示灯点亮为绿色。
- 3 利用零位调整旋钮将电流探头输出调至合适的直流偏移。

注意：测量直流信号时，只有将电流探头的位置固定才可以测得准确的直流值，否则探头位置的改变会引起直流漂移；测量交流信号时，可以移动电流探头。

- 4 连接电流探头至电路前，应打开测试夹并夹住导体，如下图所示。



图 2 测试夹与导体的连接

- 5 适当的调节电流探头和示波器以获得稳定的波形。此时，您可以同时查看到电流的 AC 和 DC 分量。当示波器的耦合方式设置为交流时，您只可以查看电流的 AC 分量。AC 分量的计算方法：示波器测得的电压幅度与当前选择的电流探头档位（50mV/A 或 500mV/A）的比值。

注意：连接不同的测量仪器所显示出来的电流会有所不同。虽然 RMS 电流只能适用于低频电流，但是其瞬时峰值可能会很高。下图为用电阻负载所绘制的电流波形与用电机控制器所绘制的区别。



图 3 典型的电流波形比较

电流探头与数字万用表的连接

请使用附件提供的 BNC 转双香蕉插头转接器将 RP1002C 电流探头 BNC 接口与数字万用表电流测量输入端连接。

测量 AC 电流时，请选择数字万用表的 ACV 功能；测量 DC 电流时，请选择数字万用表的 DCV 功能，并将探头输出调至合适的直流偏移。连接被测电流时，请注意测试夹上的电流箭头以得到正确的读数。

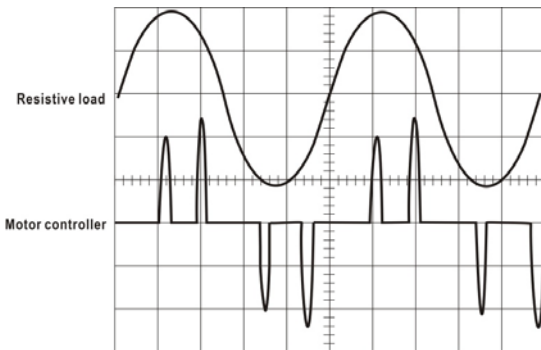
注意：若要增加 RP1002C 电流探头的测量灵敏度，只需增加测量的线缆与测试夹缠绕的圈数，电流探头的灵敏度为当前的档位与缠绕圈数的乘积，例如： $50\text{mV/A} \times 4 \text{ 圈} = 200\text{mV/A}$ 。

保养

电池

- 1 RP1002C 电流探头内置一方形 9V 的电池，本仪器属于高耗电产品，请使用指定的碱性电池。
- 2 当 RP1002C 电流探头的电池供电不足时，可能会产生较大的测量误差。当电池电压高于 6.5V 时，绿色的电池指示灯将持续点亮。

安装电池

- 1 将测试夹从电路上移开。
- 2 将后盖板上的三颗螺钉移除，取下后盖板，即可观察到电池的位置，移除电池。
- 3 将新的碱性池安装在对应的位置，安装时请注意电池的极性。
- 4 安装后盖板即可。

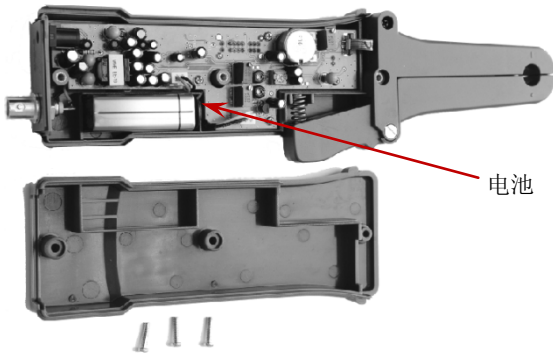

AC 电源适配器

- 1 请使用本产品指定的 AC 电源适配器，可以避免因电池耐久性不良而产生的测量误差。
- 2 当长时间使用 AC 电源适配器时，建议您将干电池取出，因为干电池遇热会产生漏液，其电解液将会腐蚀电路板，造成重大损失。此外，干电池属于高污染工业产品，建议您减少使用。

清洁

用微软湿布沾有少量清洁液或水清理电流探头的外表。若要清理内部，请把测试夹打开，并用占有异丙醇的棉布来清洗露出的表面，用轻油来润滑测试夹的齿合面。

注意：请勿使用溶剂或研磨剂清洗，请勿浸泡电流探头。

装运准备

本产品提供专用包装箱，方便收纳和装运，请勿随意丢弃。若原包装不可用，可以使用以下包装方法：

- 1 用一个稳固的包装纸盒，内部的大小要比电流探头的尺寸大一英寸。
- 2 用塑胶袋将电流探头包好以预防潮湿。
- 3 将电流探头放入包装纸盒并用轻型包装材料固定。
- 4 用胶带将包装纸盒密封。

规格

以下参数适用于已校准的 RP1002C 电流探头与任何示波器的连接，并且所使用的示波器必须在规定的操作温度（10-30℃）和湿度（0-80%RH）下连续运行 20 分钟以上。

电气特性

电流范围	50mV/A、500mV/A
典型 DC 精确度	500mV/A: $\pm 3\% \pm 20\text{mA}$ (20mA 至 14A 峰值范围) 50mV/A: $\pm 4\% \pm 200\text{mA}$ (200mA 至 100A 峰值范围) 50mV/A: $\pm 15\%$ 最大值 (100A 峰值至 140A 峰值范围)
典型增益频率关系	见附录一 1A 峰值时典型增益频率关系曲线图
最大工作电流	见电压及电流额定值
最大工作电压	见电压及电流额定值
最大浮动电压	见电压及电流额定值
频率范围	DC 至 1MHz (-3dB)
典型的电池类型与寿命	9V NEDA 1604A, IEC 6LR61 8h/次
典型的 DC 线性度	见附录三 在 50mV/A 范围时典型的 DC 线性度曲线图
典型的相位频率关系	见附录四 在 1A 峰值时相位与频率之间的关系曲线图

电压及电流额定值

参数	最大工作电流 (A)		最大工作电压 (V)	最大浮游电压 (V)
	50mV/A 范围	500mV/A 范围		
DC	70 ^[1]	7	600	600
DC+AC 峰值	70 ^[1]	7	600	600
AC 峰值	70	7	600	600
AC 峰峰值	140	14	1200	----
RMS CAT III	50	5	600	600
RMS CAT II	50	5	600	600
RMS CAT I	50	5	600	600

注^[1]: 请参考附录二 最高电流与频率之间的关系曲线图, 频率降低额定值。

物理特性

探头尺寸	262mm x 81mm x 36mm
被测导体最大尺寸	10.3mm
BP-250 同轴线缆长度	100cm
重量	310g (不含电池重量)

环境特性

工作温度	0℃至+50℃
储藏温度	-20℃至+80℃
湿度	0℃至+40℃, 湿度 95%RH +40℃至+50℃, 湿度 45%RH
污染程度	2 级

认证与符合条件

EC 符合性声明 -低电压	低电压指令：73/23/EEC，如 93/68/EEC 所修正的 EN 61010-1/A2:1995：测量、控制、调节和实验室用电设备的安全要求。第 1 部分：一般要求 EN 61010-2-032:1995：测量、控制和试验室用电设备的安全要求。第 2-032 部分：电气测量和实验用手持电流接线端子的特殊要求
其它遵从的法规	IEC61010-1/A2:1995：测量、控制、调节和实验室用电设备的安全要求。第 1 部分：一般要求 IEC61010-2-032:1994：IEC 61010-2-032-1994 测量、控制和实验室用电设备的安全要求。第 2-032 部分：电气测量和实验用手持电流接线端子的特殊要求
安装类别 （过电压）	CAT III：固定在装置中的设备，通常永久性连接 CAT II：包括电器、便携式工具以及同类产品，通常以电缆线连接 CAT I：次要的（信号级别）或电池供电的电子设备
污染程度	测量产品的周边环境或产品中可能产生的污染产品应该在规定的环境中使用。 污染指数 1： 无污染或只有不导电的污染产生，该产品一般为密封的或位于洁净室中的。 污染指数 2： 通常只有干的、不导电的污染产生，有时会因凝结而产生临时导电，通常位于办公室或家庭环境中，临时导电只会发生在无保养的情况下。

附件



RP1002C



双端 BNC 同轴线缆



AC 电源适配器



BNC 转双香蕉插头转接器

- 1 一本中英文用户手册
- 2 一条双端 BNC 同轴线缆
- 3 一个 BNC 转双香蕉插头转接器
- 4 一个符合所在国家标准的 AC 电源适配器



中英文用户手册

附录

附录一 1A 峰值时典型增益频率关系曲线图

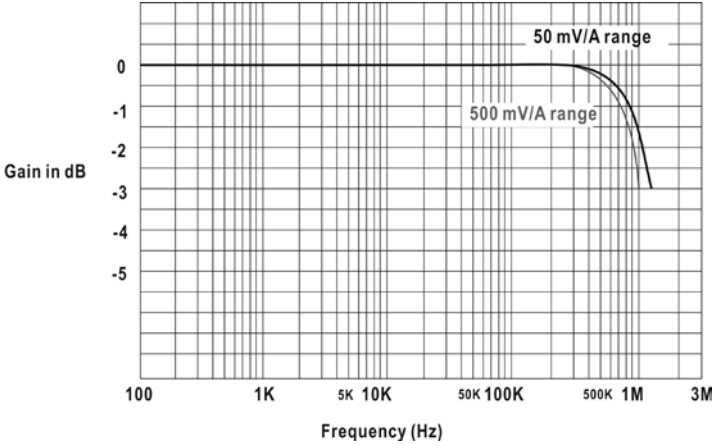

附录二 最高电流与频率之间的关系曲线图

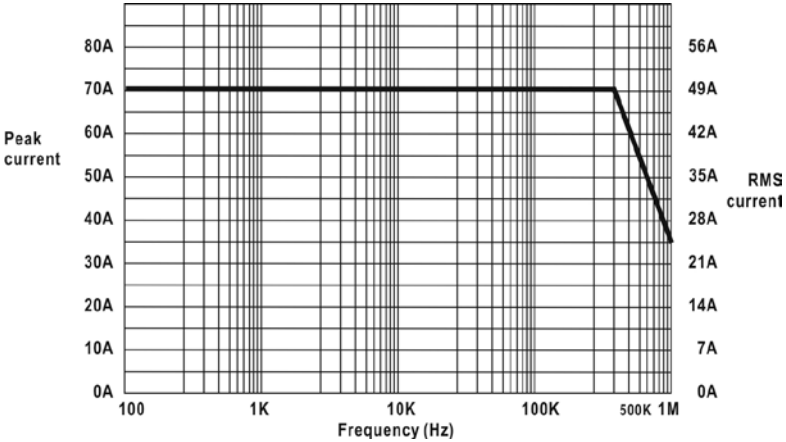

附录三 在 50mV/A 范围时典型的 DC 线性度曲线图

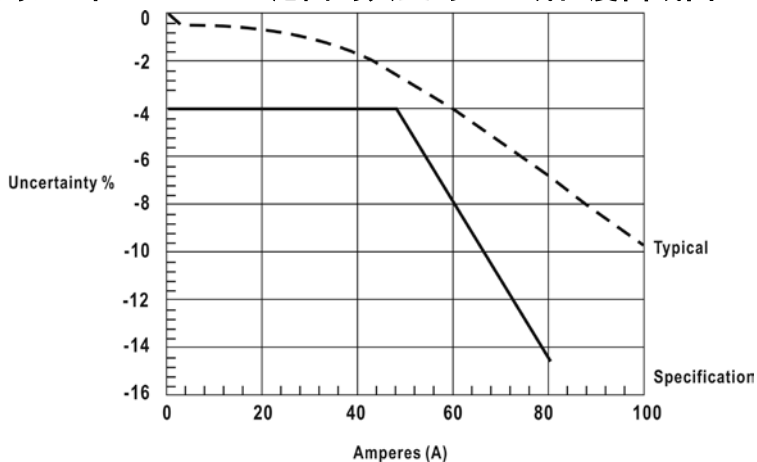

附录四 在 1A 峰值时相位与频率之间的关系曲线图(典型)

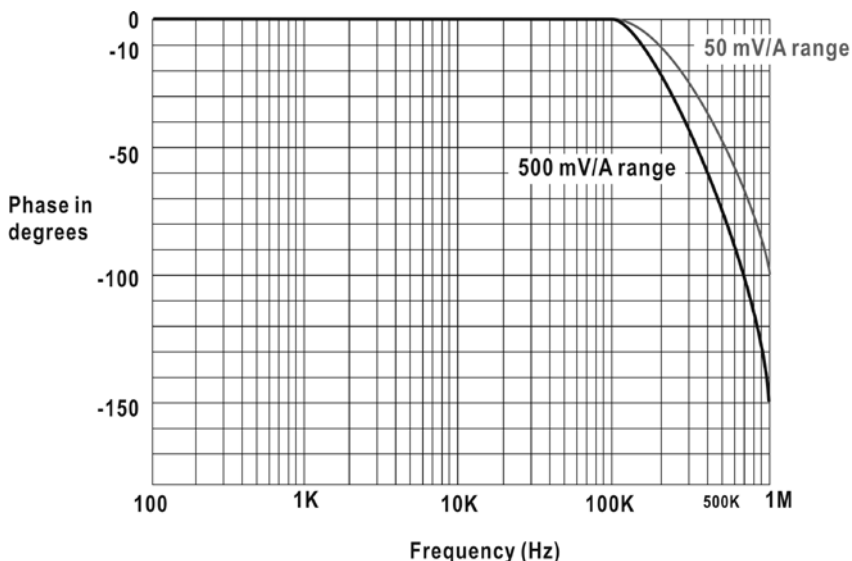

RIGOL

User's Guide

RP1002C Current Probe

Feb. 2014

RIGOL Technologies, Inc

Guaranty and Declaration

Copyright

© 2012 RIGOL Technologies, Inc. All Rights Reserved.

Trademark Information

RIGOL is a registered trademark of RIGOL Technologies, Inc.

Publication Number

UGE17103-1110

Notices

- **RIGOL** products are protected by patent law in and outside of P.R.C.
- **RIGOL** reserves the right to modify or change parts of or all the specifications and pricing policies at company's sole decision.
- Information in this publication replaces all previously corresponding material.
- **RIGOL** shall not be liable for losses caused by either incidental or consequential in connection with the furnishing, use or performance of this manual as well as any information contained.
- Any part of this document is forbidden to be copied or photocopied or rearranged without prior written approval of **RIGOL**.

Product Certification

RIGOL guarantees this product conforms to the national and industrial standards in China as well as the ISO9001:2008 standard and the ISO14001:2004 standard. Other international standard conformance certification is in progress.

Contact Us

If you have any problem or requirement when using our products or this manual, please contact **RIGOL**.

E-mail: service@rigol.com

Websites: www.rigol.com

General Safety Summary

Please review the following safety precautions carefully before putting the instrument into operation so as to avoid any personal injuries or damages to the instrument and any product connected to it. To prevent potential hazards, please use the instrument only specified by this manual.

Ground The Instrument.

The instrument is grounded through the Protective Earth lead of the power cord. To avoid electric shock, it is essential to connect the earth terminal of power cord to the Protective Earth terminal before any inputs or outputs.

Observe All Terminal Ratings.

To avoid fire or shock hazard, observe all ratings and markers on the instrument and check your manual for more information about ratings before connecting.

Replace Fuse Properly

Make sure that no overvoltage (such as voltage caused by thunderbolt) this product. Otherwise, the operator might be exposed to electric shock.

Do Not Operate Without Covers.

Do not operate the instrument with covers or panels removed.

Avoid Circuit or Wire Exposure.

Do not touch exposed junctions and components when the unit is powered.

Do Not Operate With Suspected Failures.

If you suspect damage occurs to the instrument, have it inspected by qualified service personnel before further operations. Any maintenance, adjustment or replacement especially to circuits or accessories must be performed by **RIGOL** authorized personnel.

Keep Well Ventilation.

Inadequate ventilation may cause increasing of temperature or damages to the device. So please keep well ventilated and inspect the intake and fan regularly.

Do Not Operate in Wet Conditions.

In order to avoid short circuiting to the interior of the device or electric shock, please do not operate in a humid environment.

Do Not Operate in an Explosive Atmosphere.

In order to avoid damages to the device or personal injuries, it is important to operate the device away from an explosive atmosphere.

Keep Product Surfaces Clean and Dry.

To avoid the influence of dust and/or moisture in air, please keep the surface of device clean and dry.

Electrostatic Prevention.

Operate in an electrostatic discharge protective area environment to avoid damages induced by static discharges. Always ground both the internal and external conductors of the cable to release static before connecting.

Safety Terms and Symbols

Terms in this Manual. These terms may appear in this manual:



WARNING

Warning statements indicate the conditions or practices that could result in injury or loss of life.



CAUTION

Caution statements indicate the conditions or practices that could result in damage to this product or other property.

Terms on the Product. These terms may appear on the Product:

DANGER indicates an injury or hazard may immediately happen.

WARNING indicates an injury or hazard may be accessible potentially.

CAUTION indicates a potential damage to the instrument or other property might occur.

Symbols on the Product. These symbols may appear on the product:



Double Insulation



Safety Warning



Protective Earth Terminal



Chassis Ground



Test Ground

Contents

Guaranty and Declaration	I
General Safety Summary	II
Safety Terms and Symbols	IV
RP1002C Overview	1
Basic Operation	1
Connection between the Current Probe and Oscilloscope	1
Connection between the Current Probe and Digital Meter	4
Maintenance	5
Battery.....	5
To Install the Battery	6
AC Power Adapter	6
Cleaning.....	7
Preparation for shipment	7
Specifications	8
Electrical Characteristics.....	8
Voltage and Current Ratings.....	9
Physical Characteristics.....	9
Environmental Characteristics.....	9
Certifications and Compliances	10
Accessories	11
Appendix	12
Appendix 1 Gain versus Frequency at 1 A Peak (Typical)	12
Appendix 2 Maximum Current versus Frequency	12
Appendix 3 DC Signal Linearity in 50mV/A Range (Typical) ..	13
Appendix 4 Phase versus Frequency at 1 A Peak (Typical) ...	13

RP1002C Overview

The RP1002C current probe enables a general purpose oscilloscope to display AC and DC current signals up to 100 A Peak (70 A RMS). The RP1002C current probe can also make AC and DC measurements with a multimeter by using the BNC-to-banana plug adapter.

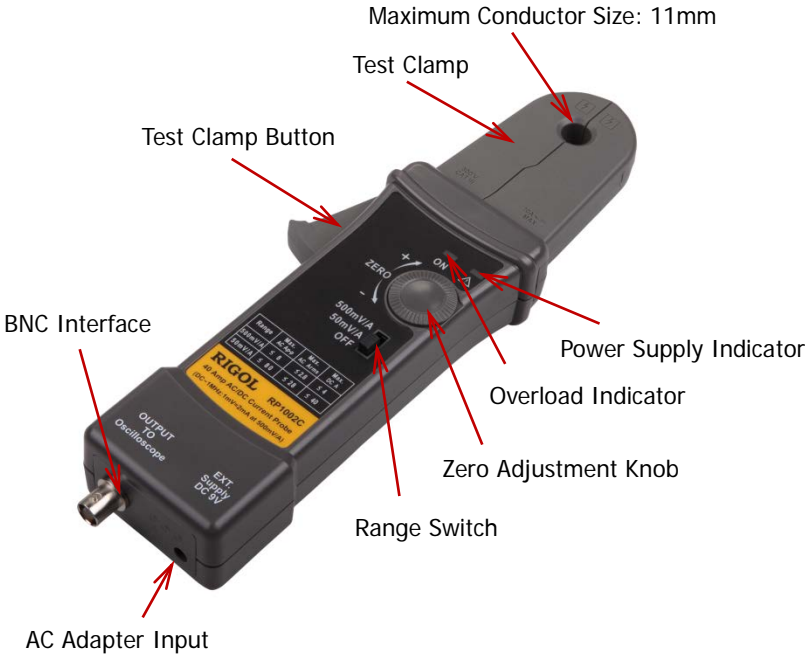
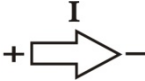





Figure 1 RP1002C Current Probe

Control/Indicator	Description
	<p>Current flow symbol: The arrow shows the positive direction of current flow</p>
	<p>Zero adjustment: After connecting to power and fixing the current probe to a fixed position, rotate the knob to adjust the probe output to the proper DC offset. It may also be used to offset a DC signal component. Zeroing is not needed for AC measurements unless your instrument cannot isolate a DC component (if present).</p>
<p>500mV/A 50mV/A OFF</p> 	<p>Range switch: Slide the switch from OFF to either the 50 mV/A or 500mV/A range. When 50 mV/A or 500mV/A is selected, the probe is turned on, and the green battery indicator (ON) lights.</p>
	<p>Power Supply indicator: The green power supply indicator lights when the probe is turned on. For more information, please refer to To Install the Battery.</p>
	<p>Overload indicator: The red overload indicator lights and flicks continuously if the measured signal is greater than the maximum range of the selected range capacity.</p>

Basic Operation

Before using the current probe, the battery or specified AC power adapter must be installed. For the battery installation instructions, refer to **To Install the Battery**.

**CAUTION**

Do not clamp the probe onto circuits with voltages greater than 600 VAC. Otherwise, personal injury or damage to the probe may result.

**CAUTION**

Always connect the RP1002C current probe output to the instrument before clamping onto the circuit under test.

Connection between the Current Probe and Oscilloscope

- 1 Set the coupling mode of the oscilloscope to DC and connect the BNC interface of the RP1002C current probe to the oscilloscope input via dual-BNC coaxial cable.
- 2 Move the Range switch to the 50 mV/A or 500 mV/A position to turn on the RP1002C current probe. At this point, the green battery indicator lights.
- 3 Use the zero adjustment knob to adjust the probe to the proper DC offset.

Note: when measuring DC signals, accurate DC value is possible only when the current probe is fixed at a certain position, otherwise, the change of the position of the probe will cause the DC drift. When measuring AC signals, users can move the current probe.

- 4 Before connecting the current probe to circuit, open the test clamp and clamp it onto the conductor as shown in the figure below.



Figure 2 Connection between the Test Clamp and Conductor

- Adjust the probe channel and oscilloscope as necessary to get a clear and stable view of the signal. At this point, you can see both the current components of AC and DC. Set the coupling mode of the oscilloscope to AC to see the current components of AC. The operation method of the current components of AC is the ratio of the voltage amplitude measured through the oscilloscope and the switch range currently selected of the current probe (50 mV/A or 500 mV/A).

Note: The current drawn by different devices look much different than that of others. While the RMS current can only be used in low frequency current, the momentary peaks may be quite high. The figure on the next page shows the difference between the line current drawn by a resistive load and a motor controller.

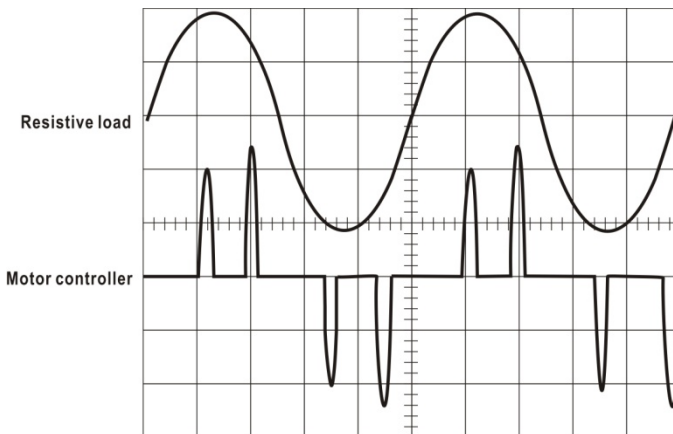

Figure 3 Typical Current Waveforms

Connection between the Current Probe and Digital Meter

Connect the BNC connector of the RP1002C current probe and the input terminal of the digital meter using the BNC-to-banana plug adapter provided with the accessories.

To measure only AC current, select the AC volts of the meter. To measure DC current, select the DC volts of the meter, and adjust the probe output to the proper DC offset. When connecting the current under test, please note the current convention arrow on the test clamp to get the proper polarity reading.

Note: To increase the measurement sensitivity of the RP1002C current probe, loop additional turns of the wire under test through the test clamp. The sensitivity of the RP1002C current probe is multiplied times the number of loops in the test clamp, for example, $50 \text{ mV/A} \times 4 \text{ turns} = 200 \text{ mV/A}$.

Maintenance

Battery

- 1 The RP1002C current probe uses a single square 9 V battery. This instrument is a high power product. Please use the specified alkaline battery.
- 2 As the battery in the RP1002C current probe is drained, significant measurement errors may occur. The green battery indicator will continue to light until a low battery voltage of 6.5 V is reached.

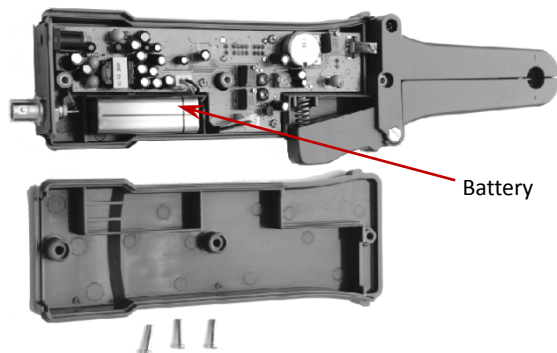

To Install the Battery

- 1 Remove the test clamp from the circuit.
- 2 Remove the three screws on the rear cover and take off the rear cover. You can see the location of the battery and remove the battery.
- 3 While observing polarity, install the new alkaline battery at the corresponding location.
- 4 Install the rear cover.

AC Power Adapter

- 1 The specified AC power adapter can be used to avoid measurement error due to poor battery durability.
- 2 When using an AC power adapter for an extended time, you are recommended to remove the battery. This is because heating will result in battery leakage, and battery electrolyte will rust the circuit board, thus creating major damage. Furthermore, as batteries are high pollution products, you are recommended to avoid using them as far as possible.

Cleaning

To clean the probe exterior, use a soft cloth dampened in a solution of mild detergent and water. To clean the core, open the test clamp and clean the exposed core surfaces with a cotton swap dampened with isopropyl alcohol (isopropanol). Lubricate the clamp mating surfaces with light oil.

Note: Do not clean with solvents or abrasives. Do not immerse the probe.

Preparation for shipment

A special box is provided to be used for this product, convenient for storage and shipment. Please do not discard it. If the original packaging is unfit for use or not available, use the following packaging guidelines.

- 1 Use a sturdy shipping carton having inside dimensions at least one inch greater than the probe dimensions.
- 2 Put the probe into a plastic bag or wrap to protect it from dampness.
- 3 Place the probe into the box and stabilize it with light packaging material.
- 4 Seal the carton with shipping tape.

Specifications

These characteristics apply to an adjusted RP1002C current probe installed on an oscilloscope of any brand. The oscilloscope must be warmed up for at least 20 minutes and be in an environment with the temperature at 10°C-30°C and the humidity at 0-80%.

Electrical Characteristics

Current Range	50mV/A, 500mV/A
DC Accuracy, typical	500mV/A: $\pm 3\% \pm 20\text{mA}$ (20mA to 14A peak range) 50mV/A: $\pm 4\% \pm 200\text{mA}$ (200mA to 100A peak range) 50mV/A: $\pm 15\%$ maximum (100A peak to 140A peak range)
Gain versus frequency, typical	See Appendix 1 Gain versus Frequency at 1 A Peak (Typical)
Max. Working Current	See Voltage and Current Ratings
Max. Working Voltage	See Voltage and Current Ratings
Max. Floating Voltage	See Voltage and Current Ratings
Frequency Range	DC to 1MHz (-3dB)
Battery Type and Life, typical	9V NEDA 1604A, IEC 6LR61 8 hours (1 each)
DC Signal Linearity, typical	See Appendix 3 DC Signal Linearity in 50mV/A Range (Typical)
Phase versus frequency, typical	See Appendix 4 Phase versus Frequency at 1 A Peak (Typical)

Voltage and Current Ratings

Parameter	Max. Working Current (A)		Max. Working Voltage (V)	Max. Floating Voltage (V)
	50mV/A Range	500mV/A Range		
DC	70 ^[1]	7	600	600
DC+AC Peak	70 ^[1]	7	600	600
AC Peak	70	7	600	600
AC Peak-peak	140	14	1200	----
RMS CAT III	50	5	600	600
RMS CAT II	50	5	600	600
RMS CAT I	50	5	600	600

Note^[1]: For frequency derating, please refer to **Appendix 2 Maximum Current versus Frequency**.

Physical Characteristics

Dimensions	262mm x 81mm x 36mm
Max. Conductor under test Size	10.3mm
Dual-BNC Coaxial Cable Length	100cm
Weight	310g (battery excluded)

Environmental Characteristics

Working Temperature	0°C to +50°C
Storage Temperature	-20°C to +80°C
Humidity	0°C to +40°C, 95% humidity +40°C to +50°C, 45% humidity
Pollution Degree	2

Certifications and Compliances

EC Declaration of Conformity – Low Voltage	Low Voltage Directive 73/23/EEC, as amended by 93/68/EEC Low Voltage Directive 73/23/EEC, as amended by 93/68/EEC EN 61010-1/A2:1995: Safety requirements for electrical equipment for measurement, control and laboratory use - Part 1: General requirements. EN 61010-2-032:1995: Safety requirements for electrical equipment for measurement, control and laboratory use - Part 2-032: Particular requirements for hand-held current clamps for electrical measurement and test.
Additional Compliance	IEC61010-1/A2:1995: Safety requirements for electrical equipment for measurement, control and laboratory use - Part 1: General requirements. IEC61010-2-032:1994: Safety requirements for electrical equipment for measurement, control, and laboratory use - Part 2-032: Particular requirements for hand-held current clamps for electrical measurement and test.
Installation (Overvoltage) Category	CAT III: Equipment in a fixed industrial location (usually permanently connected) CAT II: Equipment at this level includes appliances, portable tools, and similar products. Equipment is usually cord-connected. CAT I: Secondary (signal level) or battery operated circuits of electronic equipment.
Pollution Degree	A measure of the contaminates that could occur in the environment around and within a product. Products should be used only in the environment for which they are rated. Pollution Degree 1: No pollution or only dry, nonconductive pollution occurs. Products in this category are generally encapsulated, hermetically sealed, or located in clean rooms. Pollution Degree 2: Normally only dry, nonconductive pollution occurs. Occasionally a temporary conductivity that is caused by condensation must be expected. This location is a typical office/home environment. Temporary condensation occurs only when the product is out of service.

Accessories



RP1002C



Dual-BNC Coaxial Cable



AC Power Adapter



BNC-to-banana Plug Adapter

- 1 An Chinese and English User's Guide
- 2 A dual-BNC coaxial cable
- 3 A BNC-to-banana plug adapter
- 4 An AC power adapter that accords with the standard of the destination country.

Chinese and English
User's Guide

Appendix

Appendix 1 Gain versus Frequency at 1 A Peak (Typical)

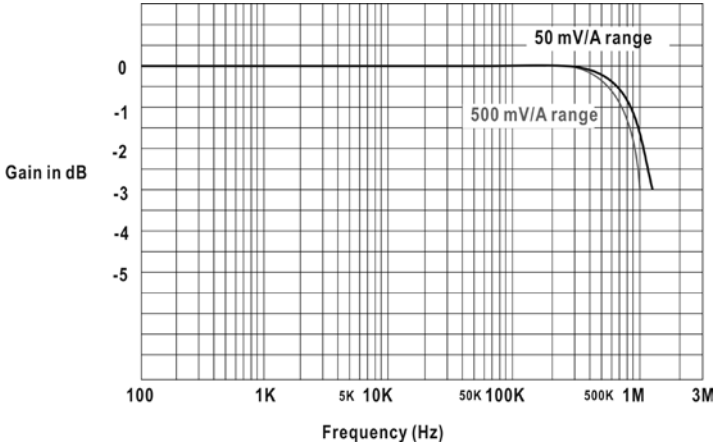

Appendix 2 Maximum Current versus Frequency

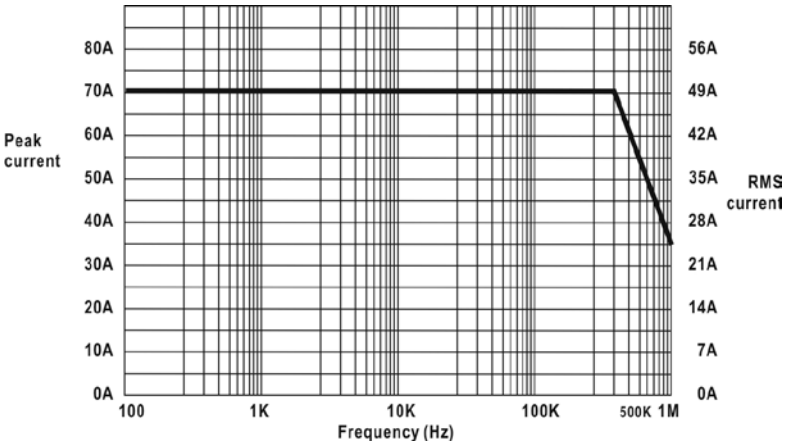

Appendix 3 DC Signal Linearity in 50mV/A Range (Typical)

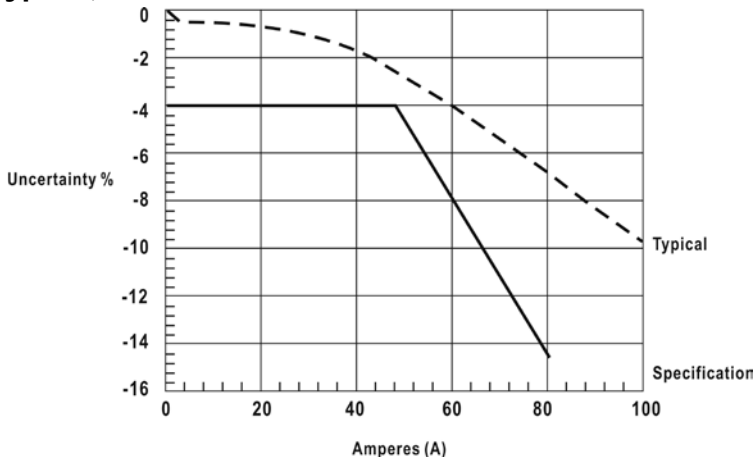

Appendix 4 Phase versus Frequency at 1 A Peak (Typical)

